

# Gebrauchsanleitung / Instructions / Mode d'emploi / Gebruiksaanwijzing / Instrucciones

**PAIDI**  
Möbel GmbH  
Hauptstraße 87  
D-97840 Hafenlohr/Main

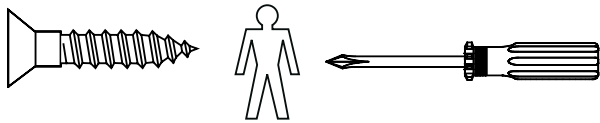
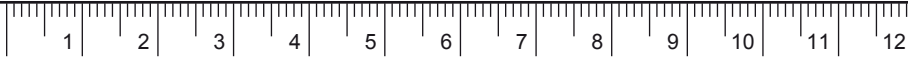

**131 5811**

**131 5812**

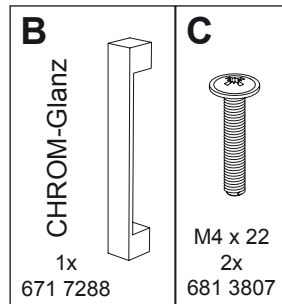
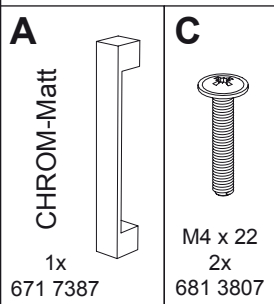

**BLAUER ENGEL**  
DAS UMWELTZEICHEN

[www.blauer-engel.de/uz38](http://www.blauer-engel.de/uz38)

- emissionsarm
- Holz aus nachhaltiger Forstwirtschaft
- in der Wohnumwelt gesundheitlich unbedenklich

**FIONA**  
**131 5811**  
**FIONA**  
**131 5812**

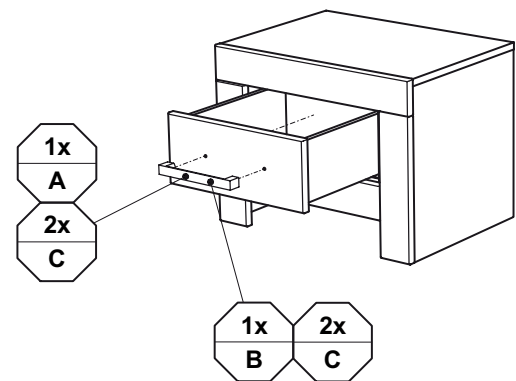
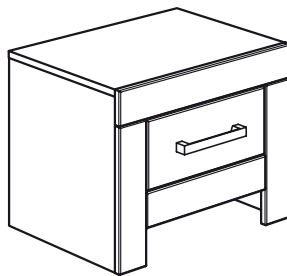

## Justierung der Schubkästen

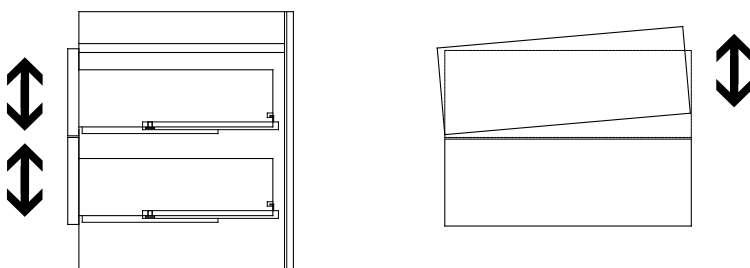

## Demontage der Schubkästen

